

26711D-SM

美制JIC内螺纹74°内锥面双六角
JIC FEMALE 74° CONE SEAT DOUBEL HEXAGON
SAE Js14

| 代号 PART Number | 螺纹E THREAD E | 软管 HOSE BORE | | 尺寸 DIMENSIONS | | | |
|----------------|-----------------|--------------|---------|---------------|------|----|----|
| | | 公称内径 DN | 标号 DASH | A | C | S1 | S2 |
| 26711D-04-04SM | 7/16" x 20 | 6 | 04 | 20 | 9 | 12 | 15 |
| 26711D-05-04SM | 1/2" x 20 | 6 | 04 | 20.5 | 9.5 | 12 | 17 |
| 26711D-06-04SM | 9/16" x 18 | 6 | 04 | 21 | 10.5 | 14 | 19 |
| 26711D-06-06SM | 9/16" x 18 | 10 | 06 | 21 | 10.5 | 17 | 19 |
| 26711D-08-06SM | 3/4" x 16 | 10 | 06 | 23 | 11 | 19 | 24 |
| 26711D-08-08SM | 3/4" x 16 | 12 | 08 | 24.5 | 11 | 22 | 24 |
| 26711D-08-10SM | 3/4" x 16 | 16 | 10 | 25.5 | 11 | 22 | 24 |
| 26711D-10-08SM | 7/8" x 14 | 12 | 08 | 24 | 13 | 22 | 27 |
| 26711D-10-10SM | 7/8" x 14 | 16 | 10 | 27 | 13 | 22 | 27 |
| 26711D-12-12SM | 1.1/16" x 12 | 20 | 12 | 31.5 | 15 | 27 | 32 |
| 26711D-16-12SM | 1.5/16" x 12 | 20 | 12 | 31.5 | 16 | 32 | 41 |
| 26711D-16-16SM | 1.5/16" x 12 | 25 | 16 | 32.5 | 16 | 32 | 41 |
| 26711D-20-20SM | 1.7/16" x 12 | 32 | 20 | 37 | 17 | 41 | 50 |

注：1.表中代号用于编织软管。 2.如需用于缠绕代号改为26712D-xx-xxSM
Note:1.For use with braided house 2.If use with spira house,hose fitting serise number is 26712D-xx-xxSM

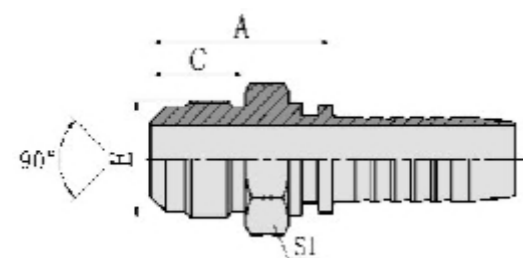

17811

美制SAE外螺纹90°外锥面
SAE MALE 90° CONE SAE J513

| 代号 PART Number | 螺纹E THREAD E | 软管 HOSE BORE | | 尺寸 DIMENSIONS | | |
|----------------|-----------------|--------------|---------|---------------|------|----|
| | | 公称内径 DN | 标号 DASH | A | C | S1 |
| 17811-04-04 | 7/16" x 20 | 6 | 04 | 25.5 | 12.7 | 12 |
| 17811-05-05 | 1/2" x 20 | 8 | 05 | 27 | 14.2 | 14 |
| 17811-06-06 | 5/8" x 18 | 10 | 06 | 28.5 | 15.7 | 17 |
| 17811-08-08 | 3/4" x 18 | 12 | 08 | 34 | 19 | 22 |
| 17811-10-10 | 7/8" x 16 | 16 | 10 | 38.5 | 22.4 | 24 |
| 17811-12-12 | 1.1/16" x 12 | 20 | 12 | 43.5 | 25.4 | 30 |

注：1.表中代号用于编织软管。 2.如需用于缠绕代号改为17812-xx-xx。
Note:1.For use with braided house 2.If use with spira house,hose fitting serise number is 17812-xx-xx.

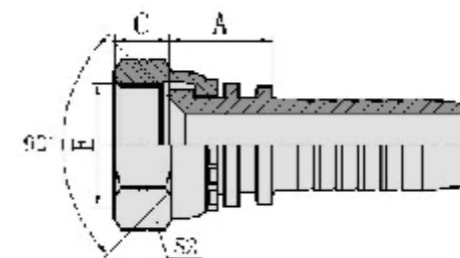

27811

美制SAE内螺纹90°内锥面
SAE FEMALE 90° CONE SEAT
SAE J513

| 代号 PART Number | 螺纹E THREAD E | 软管 HOSE BORE | | 尺寸 DIMENSIONS | | |
|----------------|-----------------|--------------|---------|---------------|------|----|
| | | 公称内径 DN | 标号 DASH | A | C | S1 |
| 27811-04-03 | 7/16" x 20 | 5 | 03 | 14 | 9 | 15 |
| 27811-04-04 | 7/16" x 20 | 6 | 04 | 15 | 9 | 15 |
| 27811-05-05 | 1/2" x 20 | 8 | 05 | 15.5 | 9.5 | 17 |
| 27811-06-04 | 5/8" x 18 | 6 | 04 | 17 | 11.3 | 22 |
| 27811-06-05 | 5/8" x 18 | 8 | 05 | 17 | 11.3 | 22 |
| 27811-06-06 | 5/8" x 18 | 10 | 06 | 17 | 11.3 | 22 |
| 27811-08-08 | 3/4" x 16 | 12 | 08 | 18 | 11 | 24 |
| 27811-10-08 | 7/8" x 14 | 12 | 08 | 18.5 | 13 | 27 |
| 27811-10-10 | 7/8" x 14 | 16 | 10 | 20 | 13 | 27 |
| 27811-12-12 | 1.1/16" x 14 | 20 | 12 | 21.5 | 14.3 | 32 |

注：1.表中代号用于编织软管。 2.如需用于缠绕代号改为27812-xx-xx。
Note:1.For use with braided house 2.If use with spira house,hose fitting serise number is 27812-xx-xx

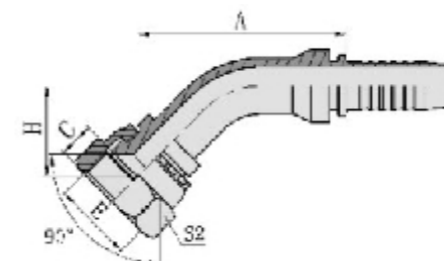

27841

45°美制SAE内螺纹90°内锥面
45° SAE FEMALE 90° CONE SEAT
SAE J513

| 代号 PART Number | 螺纹E THREAD E | 软管 HOSE BORE | | 尺寸 DIMENSIONS | | | |
|----------------|-----------------|--------------|---------|---------------|------|------|----|
| | | 公称内径 DN | 标号 DASH | A | C | H | S2 |
| 27841-04-03 | 7/16" x 20 | 5 | 03 | 37.6 | 9 | 17.2 | 15 |
| 27841-06-04 | 5/8" x 18 | 6 | 04 | 42 | 11.3 | 19.9 | 22 |
| 27841-06-05 | 5/8" x 18 | 8 | 05 | 44.1 | 11.3 | 20.7 | 22 |
| 27841-06-06 | 5/8" x 18 | 10 | 06 | 45.7 | 11.3 | 21.4 | 22 |
| 27841-08-08 | 3/4" x 16 | 12 | 08 | 58.2 | 11 | 23.3 | 24 |
| 27841-10-08 | 7/8" x 14 | 12 | 08 | 58.2 | 13 | 23.3 | 27 |
| 27841-10-10 | 7/8" x 14 | 16 | 10 | 69.4 | 13 | 24.6 | 27 |
| 27841-12-12 | 1.1/16" x 12 | 20 | 12 | 77.4 | 14.3 | 30 | 32 |

注：1.表中代号用于编织软管。 2.如需用于缠绕代号改为27842-xx-xx。
Note:1.For use with braided house 2.If use with spira house,hose fitting serise number is 27842-xx-xx

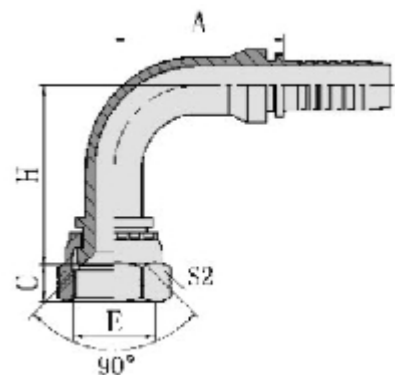

27891

90° 美制JIC内螺纹90° 内锥面
90° JIC FEMALE 90° CONE SEAT SAE J513

| 代号 PART Number | 螺纹E THREAD E | 软管 HOSE BORE | | 尺寸 DIMENSIONS | | | |
|----------------|-----------------|--------------|---------|---------------|------|------|----|
| | | 公称内径 DN | 标号 DASH | A | C | H | S2 |
| 27891-04-03 | 7/16" x 20 | 5 | 03 | 26.5 | 9 | 30.5 | 15 |
| 27891-06-04 | 5/8" x 18 | 6 | 04 | 30 | 11.3 | 36 | 22 |
| 27891-06-05 | 5/8" x 18 | 8 | 05 | 33 | 11.3 | 39 | 22 |
| 27891-06-06 | 5/8" x 18 | 10 | 06 | 35.3 | 11.3 | 41.3 | 22 |
| 27891-10-08 | 7/8" x 14 | 12 | 08 | 41 | 13 | 47 | 27 |
| 27891-10-10 | 7/8" x 14 | 16 | 10 | 56.5 | 13 | 51.5 | 27 |
| 27891-12-12 | 1.1/16" x 12 | 20 | 12 | 65.5 | 14.3 | 63.5 | 32 |

注：1.表中代号用于编织软管。
Note:1.For use with braided house

2.如需用于缠绕代号改为27892-xx-xx。
2.If use with spira house,hose fitting serise number is 27892-xx-xx

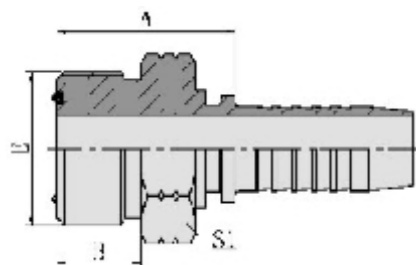

14211

美制ORFS外螺纹平面O型圈密封
ORFS MALE O-RING SEAL
ISO 4834-3-SAE Ji453

| 代号 PART Number | 螺纹E THREAD E | 软管 HOSE BORE | | O形圈 O RING | 尺寸 DIMENSIONS | | |
|----------------|-----------------|--------------|---------|---------------|---------------|------|----|
| | | 公称内径 DN | 标号 DASH | | A | C | S1 |
| 14211-04-04 | 9/16" x 16 | 6 | 04 | O011 | 22.3 | 9.8 | 17 |
| 14211-06-06 | 11/16" x 16 | 10 | 06 | O012 | 24 | 11.2 | 19 |
| 14211-08-08 | 13/16" x 16 | 12 | 08 | O014 | 28.5 | 12.8 | 22 |
| 14211-10-10 | 1" x 14 | 16 | 10 | O016 | 34 | 15.5 | 27 |
| 14211-12-12 | 1.3/16" x 12 | 20 | 12 | O018 | 36.5 | 17 | 32 |
| 14211-16-16 | 1.7/16" x 12 | 25 | 16 | O021 | 38.5 | 17.5 | 38 |
| 14211-20-20 | 1.11/16" x 12 | 32 | 20 | O025 | 41.5 | 17.5 | 46 |
| 14211-24-24 | 2" x 12 | 40 | 24 | O029 | 43.5 | 17.5 | 55 |

注：1.表中代号用于编织软管。
Note:1.For use with braided house

2.如需用于缠绕代号改为14212-xx-xx。
2.If use with spira house,hose fitting serise number is 14212-xx-xx

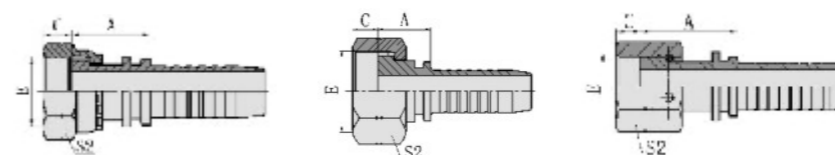

24211

24211-T

24211-W

美制ORFS内螺纹平面
ORFS FEMALE FLAT SEAT
ISO 12151-1-SAE J516

| 代号 PART Number | 螺纹E THREAD E | 软管 HOSE BORE | | 尺寸 DIMENSIONS | | |
|----------------|-----------------|--------------|---------|---------------|------|----|
| | | 公称内径 DN | 标号 DASH | A | C | S2 |
| 24211-04-04 | 9/16" x 18 | 6 | 04 | 22.5 | 8.5 | 19 |
| 24211-06-06 | 11/16" x 16 | 10 | 06 | 22.5 | 10 | 22 |
| 24211-08-08 | 13/16" x 16 | 12 | 08 | 28 | 11 | 27 |
| 24211-10-10 | 1" x 14 | 16 | 10 | 33.5 | 13.5 | 30 |
| 24211-12-12 | 1.3/16" x 12 | 20 | 12 | 35 | 15 | 36 |
| 24211-16-14T | 1.7/16" x 12 | 22 | 14 | 34 | 14.8 | 41 |
| 24211-16-16T | 1.7/16" x 12 | 25 | 16 | 35 | 14.8 | 41 |
| 24211-20-20W | 1.11/16" x 12 | 32 | 20 | 39.5 | 15 | 50 |
| 24211-20-24W | 1.11/16" x 12 | 40 | 24 | 39.5 | 15 | 50 |
| 24211-24-20T | 2" x 12 | 32 | 20 | 36 | 14.8 | 60 |
| 24211-24-24T | 2" x 12 | 40 | 24 | 36 | 14.8 | 60 |

注：1.表中代号用于编织软管。
Note:1.For use with braided house

2.如需用于缠绕代号改为24212-xx-xx。
2.If use with spira house,hose fitting serise number is 24212-xx-xx

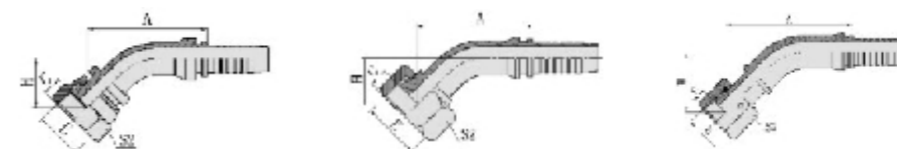

24241

24241-T

24241-W

45° 美制ORFS内螺纹平面
45° ORFS FEMALE FLAT SEAT
ISO 12151-1-SAE J516

| 代号 PART Number | 螺纹E THREAD E | 软管 HOSE BORE | | 尺寸 DIMENSIONS | | | |
|----------------|-----------------|--------------|---------|---------------|------|------|----|
| | | 公称内径 DN | 标号 DASH | A | H | C | S2 |
| 24241-04-04 | 9/16" x 18 | 6 | 04 | 45.5 | 23.4 | 8.5 | 19 |
| 24241-06-06 | 11/16" x 16 | 10 | 06 | 51.7 | 27.4 | 10 | 22 |
| 24241-08-08 | 13/16" x 16 | 12 | 08 | 65.3 | 30.4 | 11 | 27 |
| 24241-10-10 | 1" x 14 | 16 | 10 | 79.7 | 34.9 | 13.5 | 30 |
| 24241-12-12 | 1.3/16" x 12 | 20 | 12 | 87.6 | 39.5 | 15 | 36 |
| 24241-16-14T | 1.7/16" x 12 | 22 | 14 | 78.7 | 28.5 | 14.8 | 41 |
| 24241-16-16T | 1.7/16" x 12 | 25 | 16 | 84.1 | 29.7 | 14.8 | 41 |
| 24241-20-20W | 1.11/16" x 12 | 32 | 20 | 111.2 | 49 | 15 | 50 |
| 24241-20-24W | 1.11/16" x 12 | 40 | 24 | 123.6 | 52.9 | 15 | 50 |
| 24241-24-20T | 2" x 12 | 32 | 20 | 94.5 | 33.8 | 14.8 | 60 |
| 24241-24-24T | 2" x 12 | 40 | 24 | 108.5 | 37.7 | 14.8 | 60 |

注：1.表中代号用于编织软管。
Note:1.For use with braided house

2.如需用于缠绕代号改为24242-xx-xx。
2.If use with spira house,hose fitting serise number is 24242-xx-xx